

Data Sheet

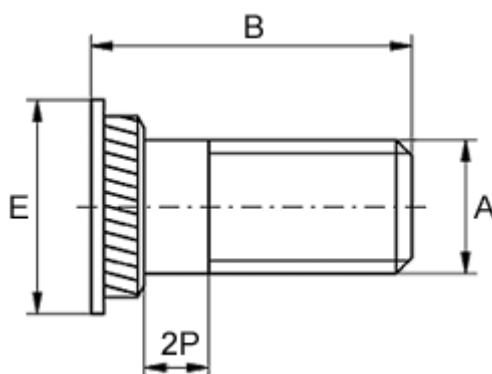

Article number: 12518700050100
Description: KLEE-coil 518 700 050.100
M5 Hardened, zinc-pl.

Measures



For plate thickness, min	= 1.5
Head diameter E	= 8
Hole diameter +0.1	= 6.4
Length B	= 18
Male thread A	= M5x0,8
Min distance to edge	= 3.3